



**RV DN 15÷50**  
PVC-C

Sediment strainer

# RV DN 15÷50

The RV Sediment strainer limits the passage of any solid particles present in the fluid by means of a strainer.

## SEDIMENT STRAINER

- Connection system for solvent weld, threaded and flanged joints
- **Strainer** mounted on an easily removed **support** that facilitates the cleaning or replacement
- **Valve material compatibility** (PVC-C) with water conveyance, drinking water and other food substances according to **current regulations**
- Can be maintained with the valve body installed

Technical specifications	
<b>Construction</b>	Sediment strainer
<b>Size range</b>	DN 15÷50
<b>Nominal pressure</b>	PN 16 with water at 20° C
<b>Temperature range</b>	0 °C ÷ 100 °C
<b>Coupling standards</b>	<b>Solvent welding:</b> EN ISO 15493, ASTM F 439. Can be coupled to pipes according to EN ISO 15493, ASTM F 441 <b>Thread:</b> UNI ISO 228-1, DIN 2999, ASTM F 437 <b>Flanging system:</b> ISO 7005-1, EN ISO 15493, EN 558-1, DIN 2501, ANSI B.16.5 cl.150
<b>Reference standards</b>	<b>Construction criteria:</b> EN ISO 15493 <b>Test methods and requirements:</b> ISO 9393 <b>Installation criteria:</b> DVS 2204, DVS 2221, UNI 11242
<b>Valve material</b>	<b>Body:</b> PVC-C <b>Strainer:</b> PP
<b>Seal material</b>	EPDM or FPM

# TECHNICAL DATA

## PRESSURE VARIATION ACCORDING TO TEMPERATURE

For water and non-hazardous fluids to which the material is classified as CHEMICALLY RESISTANT. In other cases, a reduction of the nominal pressure PN is required (25 years with safety factor).

Note: When using PVC-C at working temperatures higher than 90°, it is advisable to first contact the service centre.

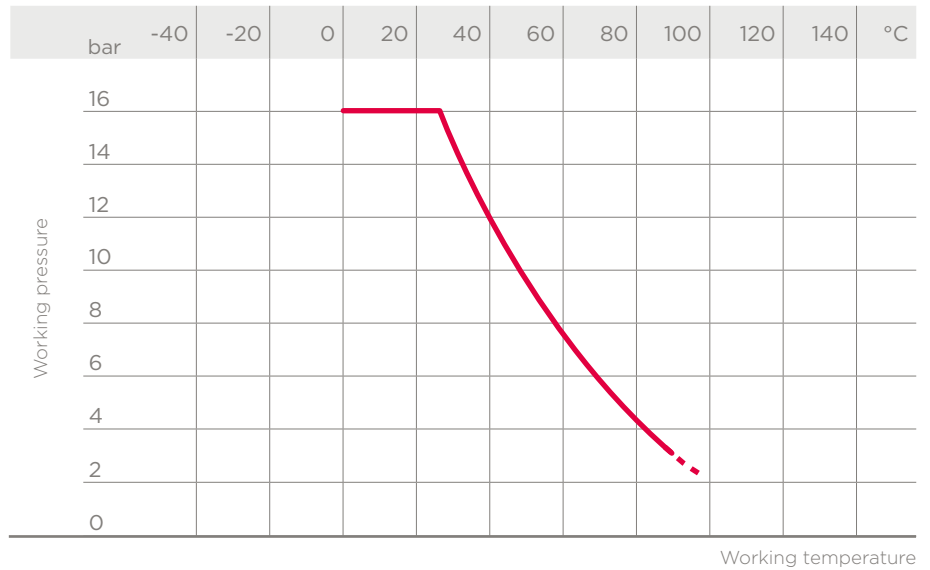

## PRESSURE DROP GRAPH

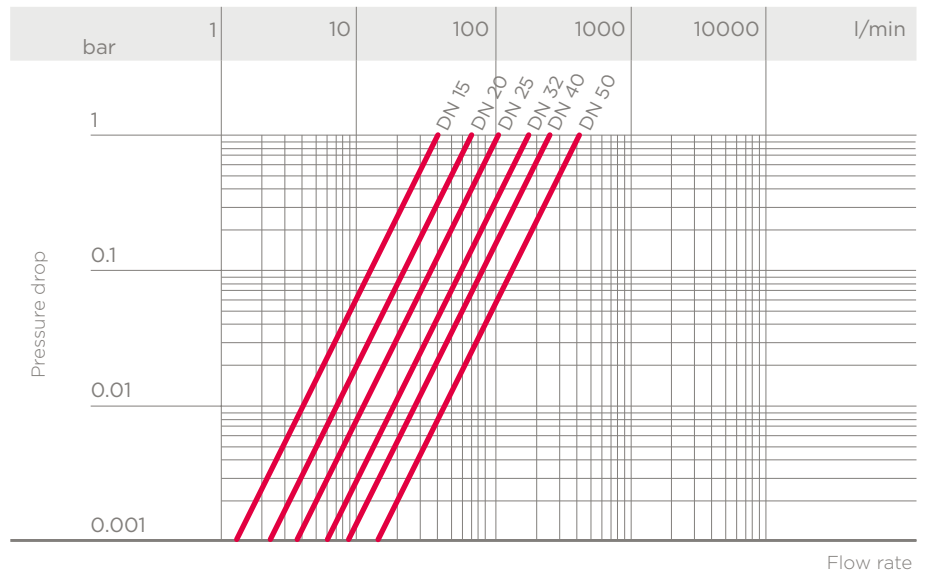

## K<sub>v</sub>100 FLOW COEFFICIENT

The K<sub>v</sub>100 flow coefficient is the Q flow rate of litres per minute of water at a temperature of 20°C that will generate Δp= 1 bar pressure drop at a certain valve position.

The K<sub>v</sub>100 values shown in the table are calculated with the valve completely open.

DN	15	20	25	32	40	50
K <sub>v</sub> 100 l/min	40	70	103	188	255	410

## STRAINER DIMENSIONS

Pitch (mm)	1.5
number of holes per cm <sup>2</sup>	42
ASTM series equivalent in mesh	20
ø equivalent hole μm	800
strainer material	PP

## TOTAL FILTER AREA $A_{tot}$ (cm<sup>2</sup>)

DN	15	20	25	32	40	50
$A_{tot}$	16	23.5	36	53	69	101

The information in this leaflet is provided in good faith. No liability will be accepted concerning technical data that is not directly covered by recognised international standards. FIP reserves the right to carry out any modification. Products must be installed and maintained by qualified personnel.

# DIMENSIONS

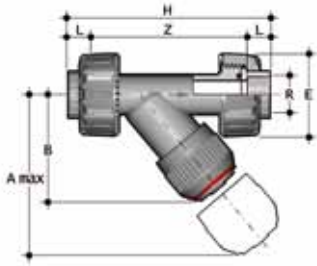

## RVUIC

Sediment strainer with female union ends for solvent welding, metric series

d	DN	PN	A max	B	E	H	L	Z	g	EPDM Code	FPM Code
20	15	16	125	72	55	135	16	103	231	RVUIC020E	RVUIC020F
25	20	16	145	84	66	158	19	120	392	RVUIC025E	RVUIC025F
32	25	16	165	95	75	176	22	132	576	RVUIC032E	RVUIC032F
40	32	16	190	111	87	207	26	155	802	RVUIC040E	RVUIC040F
50	40	16	210	120	100	243	31	181	1199	RVUIC050E	RVUIC050F
63	50	16	240	139	120	298	38	222	2018	RVUIC063E	RVUIC063F

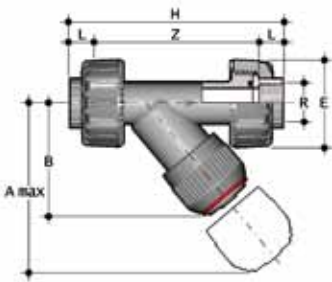

## RVUAC

Sediment strainer with female union ends for solvent welding, ASTM series

d	DN	PN	A max	B	E	H	L	Z	g	EPDM Code	FPM Code
1/2"	15	16	125	72	55	149	22.5	104	231	RVUAC012E	RVUAC012F
3/4"	20	16	145	84	66	172	25.5	121	392	RVUAC034E	RVUAC034F
1"	25	16	165	95	75	190	28.7	132.6	576	RVUAC100E	RVUAC100F
1 1/4"	32	16	190	111	87	223	32	159	802	RVUAC114E	RVUAC114F
1 1/2"	40	16	210	120	100	251	35	181	1199	RVUAC112E	RVUAC112F
2"	50	16	240	139	120	298	38.2	221.6	2018	RVUAC200E	RVUAC200F

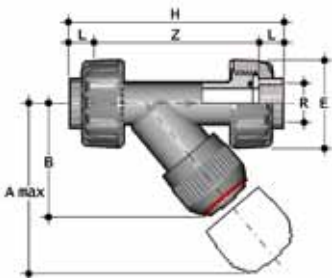

## RVUNC

Sediment strainer with NPT threaded female union ends

R	DN	PN	A max	B	E	H	L	Z	g	EPDM Code	FPM Code
1/2"	15	16	125	72	55	142	17.8	106.4	231	RVUNC012E	RVUNC012F
3/4"	20	16	145	84	66	159	18	123	392	RVUNC034E	RVUNC034F
1"	25	16	165	95	75	183	22.6	137.8	576	RVUNC100E	RVUNC100F
1 1/4"	32	16	190	111	87	214	23.5	167	812	RVUNC114E	RVUNC114F
1 1/2"	40	16	210	120	100	235	28.5	178	1211	RVUNC112E	RVUNC112F
2"	50	16	240	139	120	285	35.7	213.6	2051	RVUNC200E	RVUNC200F

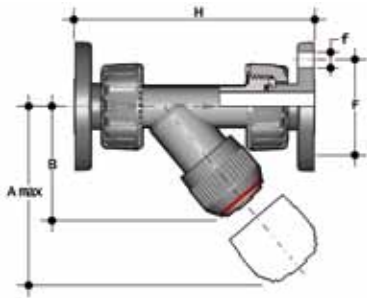

## RVUOC

Sediment strainer with fixed flanges, drilled EN/ISO/DIN PN10/16.

d	DN	PN	A max	B	F	f	H	g	EPDM Code	FPM Code
20	15	16	125	72	65	14	163	360	RVUOC020E	RVUOC020F
25	20	16	145	84	75	14	193	495	RVUOC025E	RVUOC025F
32	25	16	165	95	85	14	211	660	RVUOC032E	RVUOC032F
40	32	16	190	111	100	18	244	1000	RVUOC040E	RVUOC040F
50	40	16	210	120	110	18	277	1320	RVUOC050E	RVUOC050F
63	50	16	240	139	125	18	331	1910	RVUOC063E	RVUOC063F

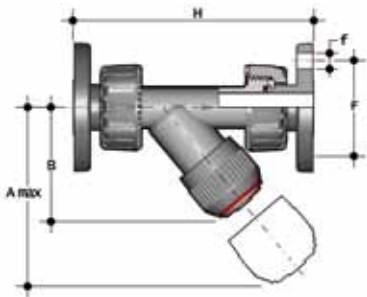

## RVUOAC

Sediment strainer with fixed flanges, drilled ANSI B16.5 cl.150 #FF

d	DN	PN	A max	B	F	f	H	g	EPDM Code	FPM Code
1/2"	15	16	125	72	60.3	15.9	175	360	RVUOAC012E	RVUOAC012F
3/4"	20	16	145	84	69.9	15.9	214	495	RVUOAC034E	RVUOAC034F
1"	25	16	165	95	79.4	15.9	237	660	RVUOAC100E	RVUOAC100F
1 1/4"	32	16	190	111	88.9	15.9	253	1000	RVUOAC114E	RVUOAC114F
1 1/2"	40	16	210	120	98.4	15.9	289	1320	RVUOAC112E	RVUOAC112F
2"	50	16	240	139	120.7	19.1	333	1910	RVUOAC200E	RVUOAC200F

# COMPONENTS

## EXPLODED VIEW

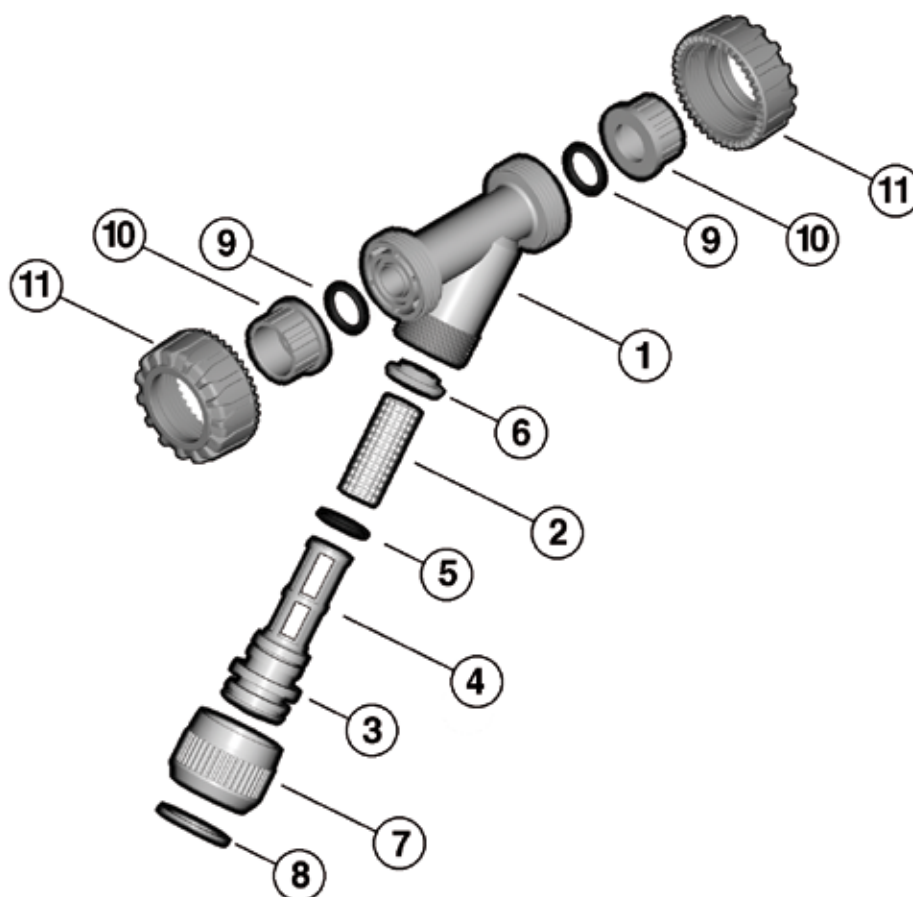

**1** • Body (PVC-C - 1)

**2** • Strainer (PP-H - 1)\*

**3** • Bonnet (PVC-C - 1)

**4** • Strainer support (PVC-C - 1)

**5** • O-Ring (EPDM o FPM - 1)\*

**6** • Washer (PVC-C - 1)

**7** • Union nut (PVC-C - 1)

**8** • Retaining ring (PVC-C - 1)

**9** • Socket seal O-ring  
(EPDM or FPM - 2)\*

**10** • End connector (PVC-C - 2)\*

**11** • Union nut(PVC-C - 2)

\* Spare parts

The material of the component and the quantity supplied are indicated between brackets

## DISASSEMBLY

- 1) Isolate the sediment strainer from the fluid flow and empty the system upstream.
- 2) Unscrew the nut (7) and separate the bonnet-support (3-4) from the body (1).
- 3) Remove the bottom washer (6) from the bonnet-support (3-4).
- 4) Remove the retaining ring (8) and separate the union nut (7) from the bonnet (3).
- 5) Remove the O-Ring from the bonnet (5).

## ASSEMBLY

- 1) Insert the O-Ring (5) in its seating in the bonnet (3).
- 2) Insert the bonnet (3) in union nut (7) and fix the two components using the retaining ring (8).
- 3) Insert the strainer (2) in the bonnet-support (3-4) and hold in place with the washer (6).
- 4) Insert the bonnet (3) in the body (1) and tighten the union nut (7).



**Note:** maintenance operations can be carried out with the valve body installed. During assembly, it is advisable to lubricate the rubber seals. Mineral oils are not recommended for this task as they react aggressively with EPDM rubber.

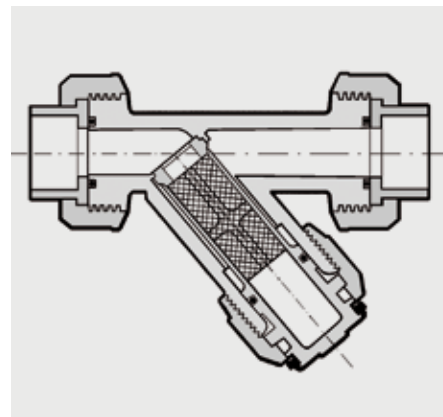

## INSTALLATION

The sediment strainer can be installed in any position, making sure that the arrow stamped on the body indicates the direction of fluid flow and that the strainer part is facing downwards. To avoid damaging the strainer, appropriate devices must be installed on the line to prevent backflow.

- 1) Unscrew the union nuts (11) and slide them onto the pipe.
- 2) Heat weld the end connectors (10) onto the pipe segments.
- 3) Position the sediment strainer between the connectors
- 4) Tighten the union nuts.

## WARNINGS

- sediment strainers with a transparent body allow the passage of light, thus promoting the internal growth of algae and micro-organisms.
- sediment strainers with a transparent body are not protected against solar rays. Use in an open-air system will accelerate the ageing process of the material and reduce its working life.
- The sediment strainers with a transparent body located near pumps should be protected against vibrations.
- Always check the cleanliness of the filter elements.